

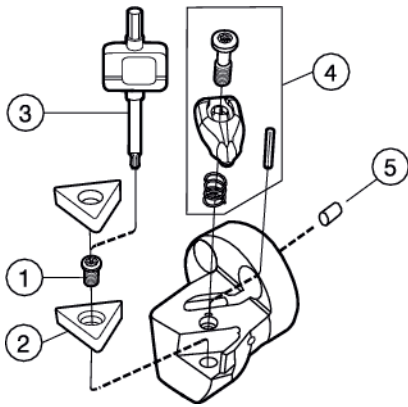



CoroTurn® RC-System



	1	2	3	4	5
Schneidköpfe	Schraube für Zwischenlage	Zwischenlage (Für Plattendicke)	Schlüssel (Torx Plus/mm)	Kompletter Spannsatz	Rohrpassstift
					
570-DCLNR/L-32-09	5513 020-04	5322 236-04	5680 051-03 (9IP)	5412 028-011 ¹⁾	5638 031-01
570-DCLNR/L-32-12-L	5513 020-02	5322 236-03	5680 049-01 (15IP)	5412 028-021 ¹⁾ 5412 034-021 ²⁾ 5412 032-021 ³⁾	5638 031-01
570-DCLNR/L-40-12-L					
570-DCLNR/L-40-16-L	5513 020-07	5322 234-03	5680 043-14 (20IP)	5412 028-031	5638 031-01
570-DCLNR/L-40-19-L	5513 020-07	5322 236-01	5680 043-14 (20IP)	5412 028-041	5638 031-01
					
570-DDUNR/L-32-11	5513 020-04	5322 267-01	5680 051-03 (9IP)	5412 028-011 ¹⁾	5638 031-01
570-DDUNR/L-32-11X					
570-DDUNR/L-40-15	5513 020-02	5322 266-02 (.250) 5322 266-01 (.187) ⁴⁾	5680 049-01 (15IP)	5412 028-021 ¹⁾ 5412 034-021 ²⁾ 5412 032-021 ³⁾	5638 031-01
570-DDUNR/L-40-15X					
570-DDXNR/L-32-11	5513 020-04	5322 267-01	5680 051-03 (9IP)	5412 028-011 ¹⁾	5638 031-01
570-DDXNR/L-40-15-L	5513 020-02	5322 266-02 (.250) 5322 266-01 (.187) ⁴⁾	5680 049-01 (15IP)	5412 028-021 ¹⁾ 5412 034-021 ²⁾ 5412 032-021 ³⁾	5638 031-01
					
570-DTFNR/L-32-16-L	5513 020-04	5322 316-01	5680 051-03 (9IP)	5412 028-011 ¹⁾	5638 031-01
570-DTFNR/L-40-16-L					
					
570-DWLNR/L-32-06	5513 020-04	5322 328-01	5680 051-03 (9IP)	5412 028-011 ¹⁾	5638 031-01
570-DWLNR/L-32-08-LE	5513 020-02	5322 331-12	5680 049-01 (15IP)	5412 028-021 ¹⁾ 5412 034-021 ²⁾ 5412 032-021 ³⁾	5638 031-01
570-DWLNR/L-40-08-L					

- 1) Spannsatzteile siehe Seite A359.
- 2) Spannsätze für Keramikplatten ohne Bohrung
- 3) Spannsätze für Keramikplatten mit Bohrung
- 4) Zusatzteile Lieferung auf gesonderte Bestellung

T-Max P Hebelspann-System

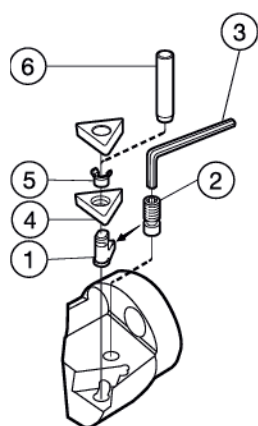

	1	2	3	4		5	6
Schneidköpfe	Kniehebel	Schraube	Schlüssel (mm)	Zwischenlage	Für Plattendicke (Radius)	Rohrstift für Zwischenlage	Montagedorn
R/L 571.31C-323222-12	174.3-848M	174.3-858	174.1-864 (3.0)	171.31-850M	.188 (.016-.063)	174.3-861	174.3-871
R/L 571.31C-403227-12	174.3-841M	174.3-821	174.1-864 (3.0)	171.31-850M	.188 (.016-.063)	174.3-861	174.3-871
R/L 571.31C-504035-16	438.3-840	438.3-831	174.1-864 (3.0)	171.31-852	.250 (.016-.094)	174.3-864	174.3-873
R/L 571.31C-604043-16							
R/L 571.35C-403227-15	174.3-847M	174.3-830	174.1-864 (3.0)	171.35-851M 171.35-850M ¹⁾	.250 (.016-.031) .250 (.047-.063)	174.3-861	174.3-871
R/L 571.35C-504035-15					171.35-856 ¹⁾	.188 (.016-.031)	
R/L 571.35C-604043-15					171.35-855 ¹⁾	.188 (.047-.063)	

1) Lieferung auf gesonderte Bestellung

CoroTurn® HP Hebelspann-System

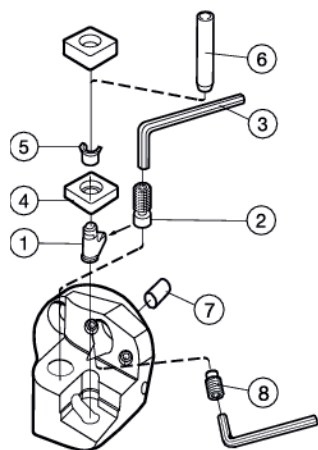





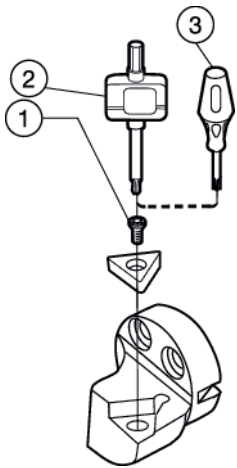

	1	2	3 ¹⁾	4 ¹⁾	5	6 ¹⁾	7 ¹⁾	8
	Kniehebel	Schraube	Schlüssel (mm)	Zwischenlage	Rohrstift für Zwischenlage	Montagedorn	Rohrpassstift	Düse (Bohrungsdurchmesser, mm)
SL-PCLNR-25-09HP-G	174.3-845-1	174.3-829	170.3-864	-	-	-	5552 058-02	5691 026-13 (1.0)
SL-PCLNR/L-32-12HP	174.3-848	174.3-858M	174.1-864 (3.0)	171.31-850M	174.3-861	174.3-871	5638 031-01	5691 026-03 (1.0)
SL-PCLNR/L-40-12HP	174.3-841M	174.3-821	174.1-864 (3.0)	171.31-850M	174.3-861	174.3-871	5638 031-01	5691 026-03 (1.0)
SL-PCLNR/L-40-16HP	438.3-840	438.3-831	174.1-864 (3.0)	171.31-852	174.3-864	174.3-873	5638 031-01	5691 026-03 (1.0)
SL-PDUNR/L-25-11HP-G	5432 015-021	438.3-830	174.1-870	-	-	-	5552 058-02	5691 026-13 (1.0)
SL-PDUNR/L-32-11HP	5432 001-01	174.3-820M	174.1-863 (2.5)	5322 255-01	174.3-860	174.3-870	5638 031-01	5691 026-03 (1.0)
SL-PDUNR/L-40-15HP	174.3-847M	174.3-830	174.1-864 (3.0)	171.35-851M	174.3-861	174.3-871	5638 031-01	5691 026-03 (1.0)
SL-PTFNR/L-32-16HP	174.3-840M	174.3-820M	170.3-860 (2.5)	179.3-850M	174.3-860	174.3-870	5638 031-01	5691 026-03 (1.0)
SL-PTFNR/L-40-16HP	174.3-840M	174.3-820M	170.3-860 (2.5)	179.3-850M	174.3-860	174.3-870	5638 031-01	5691 026-03 (1.0)

Optionale Düsen (gesondert zu bestellen)

Bestellnummer	Bohrungsdurchmesser
5691 026-01	0.6
5691 026-02	0.8
5691 026-04	1.2
5691 026-05	1.4

CoroTurn® 111/107 Schraubspannsystem



	1	2	3 ¹⁾
Schneidköpfe	Schraube für Wendeplatte (Gewinde)	Schlüssel (Torx Plus)	Schraubendreher (Torx Plus)
 570-SCLPR/L-16-06	5513 020-46 (M2.5)	5680 051-02 (7IP)	5680 046-03 (7IP)
 570-SDUPR/L-16-07 570-SDUPR/L-20-07 570-SDUPR/L-25-11 570-SDXPR/L-16-07-E 570-SDXPR/L-20-07-E 570-SDXPR/L-25-07-E 570-SDXPR/L-16-07-EX 570-SDXPR/L-20-07-EX 570-SDXPR/L-25-07-EX	5513 020-03 (M2.5)	5680 051-02 (7IP)	5680 046-03 (7IP)
 570-STFPR/L-16-11 570-STFPR/L-20-11 570-STFPR/L-25-11 CoroTurn® 107	5513 020-03 (M2.5)	5680 051-02 (7IP)	5680 046-03 (7IP)
 570-SVQCR/L-20-11-E 570-SVQCR/L-25-11-D 570-SVUCR/L-20-11-E 570-SVUCR/L-25-11-D CoroTurn® 111	5513 020-03 (M2.5)	5680 051-02 (7IP)	5680 046-03 (7IP)
 570-SWLPR/L-16-04	5513 020-46 (M2.5)	5680 051-02 (7IP)	5680 046-03 (7IP)

Magnetische Spannhülse, siehe Seite A371

1) Zusatzteile Lieferung auf gesonderte Bestellung

CoroTurn® 107 Schraubspannsystem

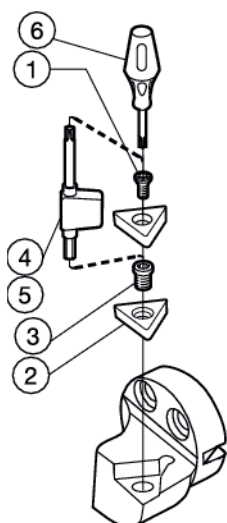

Schneidköpfe	1	2	3	4/5	6 ²⁾
	Schraube für Wendeplatte (Gewinde)	Zwischenlage	Für Plattendicke (Radius)	Schraube für Zwischenlage (Gewinde)	Schraubendreher (Torx Plus)
570-SCLCR/L-16-06	5513 020-03 (M2.5)	-	-	-	5680 051-02 (7IP) 5680 046-03 (7IP)
570-SCLCR/L-20-09	5513 020-09 (M3.5)	-	-	-	5680 049-01 (15IP/3.5) 5680 046-02 (15IP)
570-SCLCR/L-25-09	5513 020-10 (M3.5)	-	-	-	5680 049-01 (15IP/3.5) 5680 046-02 (15IP)
570-SDUCR/L-16-07	5513 020-03 (M2.5)	-	-	-	5680 051-02 (7IP) 5680 046-03 (15IP)
570-SDUCR/L-16-07EX					
570-SDUCR/L-20-07EX					
570-SDUCR/L-25-07DX					
570-SDXCR/L-16-07-E					
570-SDXCR/L-20-07-E					
570-SDXCR/L-25-07-E					
570-SDUCR/L-20-11	5513 020-09 (M3.5)	-	-	-	5680 049-01 (15IP/3.5) 5680 046-02 (15IP)
570-SDUCR/L-25-11	5513 020-10 (M3.5)	-	-	-	5680 049-01 (15IP/3.5) 5680 046-02 (15IP)
570-SDUCR/L-32-11	5513 020-01 (M3.5)	5322 263-01	.156 (.016-.031)	5512 090-01	5680 049-01 (15IP/3.5) 5680 046-02 (15IP)
570-SDUCR/L-32-11X		5322 263-02 ¹⁾	.156 (.047)		
570-SDUCR/L-40-11					
570-SDUCR/L-40-11X					
570-SDXCL-32-11X	5513 020-01 (M3.5)	5322 263-01	.156 (.016-.031)	5512 090-01	5680 049-01 (15IP/3.5) 5680 046-02 (15IP)
570-SDXCL-32-11X		5322 263-02 ¹⁾	.156 (.047)		
570-SDXCL-40-11X	5513 020-01 (M3.5)	5322 263-01	.156 (.016-.031)	5512 090-01	5680 049-01 (15IP/3.5) 5680 046-02 (15IP)
570-SDXCL-40-11X		5322 263-02 ¹⁾	.156 (.047)		
570-STFCR/L-16-09	5513 020-05 (M2.2)	-	-	-	5680 051-02 (7IP) 5680 046-03 (7IP)
570-STFCR/L16-11-B1 ³⁾	5513 020-03 (M2.5)	-	-	-	5680 051-02 (7IP) 5680 046-03 (7IP)
570-STFCR/L-20-11-B1 ³⁾					
570-STFCR/L-25-11-B1 ³⁾					
570-STFCR/L-32-16	5513 020-01 (M3.5)	5322 320-01	.156 (.016-.047)	5512 090-01	5680 049-01 (15IP/3.5) 5680 046-02 (15IP)
570-STFCR/L-40-16	5513 020-01 (M3.5)	5322 320-01	.156 (.016-.047)	5512 090-01	5680 049-01 (15IP/3.5) 5680 046-02 (15IP)
570-SVLBR/L-25-16-LF	5513 020-10	-	-	-	5680 049-01 (15IP/3.5) 5680 046-02 (15IP)
570-SVLBR/L-32-16	5513 020-10	5322 270-01		5512 090-01	5680 049-01 (15IP/3.5) 5680 046-02 (15IP)
570-SVLBR/L-40-16					
570-SVPBR/L-32-16-L					
570-SVPBR/L-40-16-L					
570C-SVUBR/L-20-2	5513 020-03	-	-	-	5680 051-02 (7IP) 5680 046-03 (7IP)
570C-SVUBR/L-25-2	(M2.5)				

1) Optionen sind separat zu bestellen.

2) Zusatzteile Lieferung auf gesonderte Bestellung

3) B1 = Für Wendeschneidplatten mit einer Dicke von 2 = 1/8"

Magnetische Spannhülse, siehe Seite A371

Hinweis: CoroTurn® 107 Schneidkopftyp SVQPR/L siehe Seite I108.

CoroTurn® TR Schraubspann-System

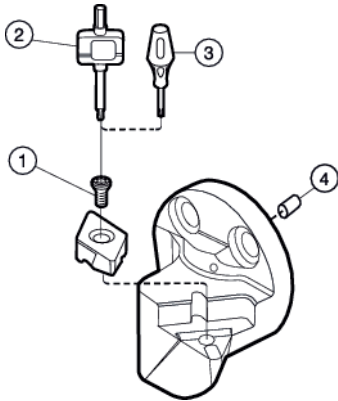

	1	2	3 ¹⁾	4 ¹⁾
Schneidköpfe	Schraube für Wendeplatte	Schlüssel (Torx Plus/mm)	Torx-Schlüssel	Rohrpassstift
TR-SL-D13UCR/L-25 TR-SL-D13UCR/L-25X TR-SL-D13XCR/L-25 TR-SL-D13UCR/L-32 TR-SL-D13UCR/L-40 TR-SL-D13UCR/L-32X TR-SL-D13UCR/L-40X TR-SL-D13XCR/L-32 TR-SL-D13XCR/L-40	5513 020-01	5680 049-01(15IP)	5680 100-06	5552 058-02
TR-SL-V13PBR/L-25 TR-SL-V13LBR/L-25 TR-SL-V13PBR/L-32 TR-SL-V13PBR/L-40 TR-SL-V13LBR/L-32 TR-SL-V13LBR/L-40	5513 020-64	5680 049-04(10IP)	5680 100-05	5552 058-02
	5513 020-64	5680 049-04(10IP)	5680 100-05	5638 031-01

CoroTurn® TR Schraubspannsystem mit Hochdruck-Kühlschmierstoff

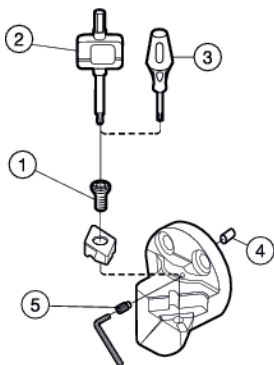

Optionale Düsen (gesondert zu bestellen)

Bestellnummer	Bohrungsdurchmesser, mm
5691 026-01	0.6
5691 026-02	0.8
5691 026-04	1.2
5691 026-05	1.4

	1	2	3 ¹⁾	4 ¹⁾	5
Innenbearbeitung	Schraube für Wendeplatte	Schlüssel (Torx Plus)	Torx-Schlüssel	Rohrpassstift	Düse (Bohrungsdurchmesser, mm)
TR-SL-D13UCR/L-32HP TR-SL D13UCR/L-40HP TR-SL-V13LBR/L-32HP TR-SL-V13LBR-40HP	5513 020-01	5680 049-01 (15IP)	5680 100-06	5638 031-01	5691 026-03 (1.0)
	5513 020-64	5680 049-04 (10IP)	5680 100-05	5638 031-01	5691 026-03 (1.0)
Außenbearbeitung					
TR-SL-D13JCR/L-32HP-X TR-SL-D13JCR/L-40HP-X TR-SL-V13JBR/L-32HP-X	5513 020-01	5680 049-01 (15IP)	5680 100-06	5638 031-01	5691 026-03 (1.0)
	5513 020-64	5680 049-01 (10IP)	5680 100-05	5638 031-01	5691 026-03 (1.0)